

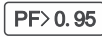

Art nr.: S22-210BOX

E-nr:



RoHS



(Ongoing)

Model No.	S22-BOX1000
Input Voltage	AC100-240V 50/60Hz
Output Voltage	DC320-340V
Built-in driver	4 pcs
Extra 20KV SPD	✓
G2.0 driver control board	✓
Dimmable	0/10V
AC /DC cable (optional)	3-core 1.5/2.5mm ²
Dimension	540 x 275 x 69 mm
Net weight	6.2 Kg

Dimensions (Unit: mm)

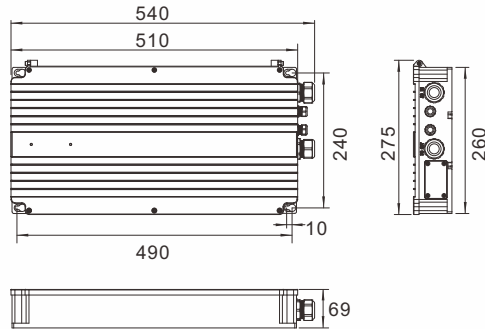

Wiring of separated control gear solution



(1) Connection of luminaire

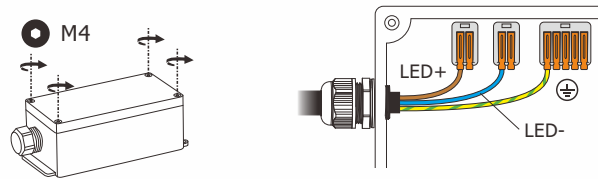

(2) Connection of control gear (Dali)

LED+	LED-	Dim-	Dim-	Dim+	Dim+	L	L	N	N	PE	PE	PE	PE
<input type="checkbox"/>	<input type="checkbox"/>	<input type="checkbox"/>	<input type="checkbox"/>	<input type="checkbox"/>	<input type="checkbox"/>	<input type="checkbox"/>	<input type="checkbox"/>	<input type="checkbox"/>	<input type="checkbox"/>	<input type="checkbox"/>	<input type="checkbox"/>	<input type="checkbox"/>	<input type="checkbox"/>
<input type="checkbox"/>	<input type="checkbox"/>	<input type="checkbox"/>	<input type="checkbox"/>	<input type="checkbox"/>	<input type="checkbox"/>	<input type="checkbox"/>	<input type="checkbox"/>	<input type="checkbox"/>	<input type="checkbox"/>	<input type="checkbox"/>	<input type="checkbox"/>	<input type="checkbox"/>	<input type="checkbox"/>

Label	Description
LED+	LED+ Connection
LED-	LED- Connection
Dim-	Dim- Connection
Dim+	Dim+ Connection
L	Live
N	Null
PE	Protection Earth

Stripping Length

⚠ Note: According to the actual needs, the number of connectors will increase or decrease. Different dimming function cannot be used at the same time.

(3) Cable gland of Matrix

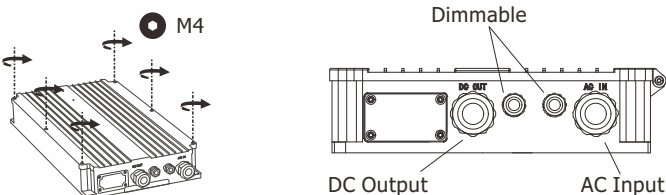

Connection	Cable Gland	Toque (N*m)	Cable Diameter (mm)	Cable Section (mm ²)
AC Input	M20	5.5	8-10/10-12	1.5/2.5
DC Output	M20	5.5	8-10/10-12	1.5/2.5
Dimmable	M16	2.5	7-10	1.0-1.5



Installation ways



Control Gear on the lamp



Control Gear fixed on the pole



Control Gear put in the electric cabinet

Note:

Installation of control gear (driver box)

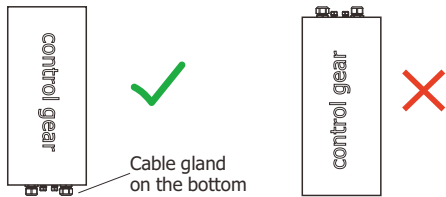

Cable gland on the bottom

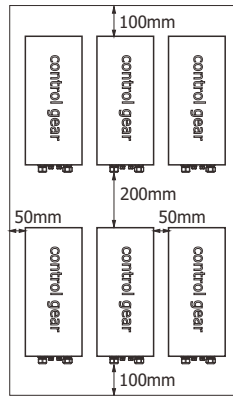

The minimum distances between control gear or wall

Caution:

1. Waterproof connectors and installation tools are not included. Installation and maintenance must be performed by qualified person.
2. screws were tighten up.
3. Ground wire must be well connected.
4. Please make sure the control gear is working with correct input voltage.
5. Do not use chemicals or corrosive cleaner to clean this.
6. The minimum clearance distance from the top and sides of the control gear to normally flammable building elements is 10 cm.
7. WARNING: FELV terminals marked "Risk of electric shock" are not safe to touch.

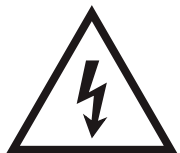
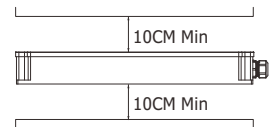

Danger: electricity

WARNING: Circuits connected to any FELV control terminal shall be insulated for the LV supply voltage of the control gear and any terminals connected to the FELV circuit shall be protected against accidental contact.

Utilization of used lamps

Control gear must be disposed of in accordance with current regulations concerning environmental protection. Proper utilization of equipment enables preserving valuable environmental resources and avoiding adverse impacts on health and the environment, which may be threatened by inappropriate waste handling.

