



DESIGNLIGHT

SCANDINAVIAN AB

Art nr.: S22-16

E-nr:

Watt	Material	Kelvin	CRI	Armaturfärg	Effekt	Lumen(lm)
Watt	Material	Kelvin	CRI	Armature color	Effect	Lumen(lm)
600W	Aluminum	4000K	>70	Black	133lm/W	79,900LM
600W	Aluminum	4000K	>90	Black	113lm/W	68,000LM

CCT 3000K-6000K
 IP66
 IK10
 LM79
 LM80
 TM21
 PF > 0.95

DALI 2

 40°x15° 60°x15° 100°x17° 100°x60° 130°x25° 12° 30° 60°

- 133lm/w med lens, driver
- 180 lm/w utan lens, driver
- CRI Värde >70/>90
- 133lm/w with lens and driver
- 180lm/w without lens and driver
- CRI>70/>90

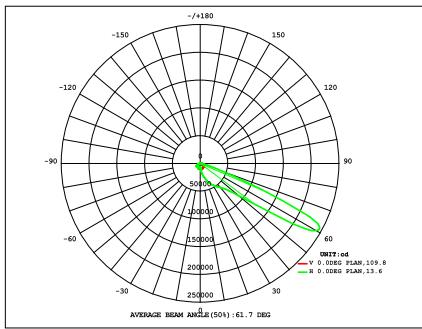

Dimensions

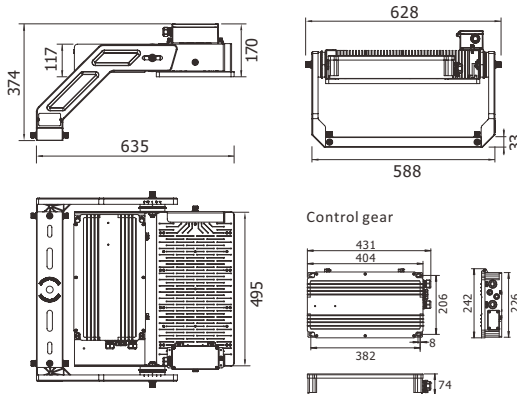

Flux out: 471.0 lm

Height	Eavg, Emax	Angle: 13.55deg	Diameter
2m	2486,3258lx		47.53cm
4m	621.5,814.6lx		95.06cm
6m	276.2,362.1lx		142.59cm
8m	155.4,203.7lx		190.12cm
10m	99.44,130.3lx		237.66cm
12m	69.05,90.5lx		285.19cm
14m	50.73,66.5lx		332.72cm
16m	38.84,50.9lx		380.25cm
18m	30.69,40.2lx		427.78cm
20m	24.86,32.5lx		475.31cm

Note: The Curves indicate the illuminated area and the average illumination when the luminaire is at different distance.

Installation

This Modular floodlight can be installed on pole, wall, ceiling or on a horizontal surface.

Note: Considering the heat dissipation, load bearing and dust accumulation, some installation methods are not allowed.

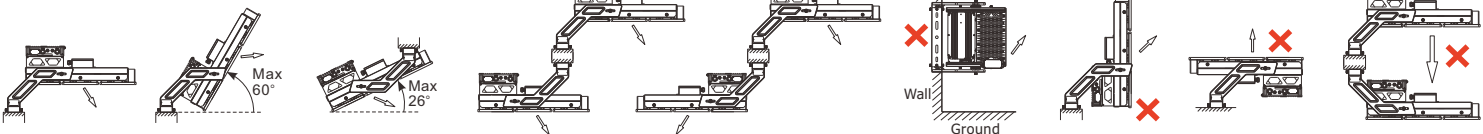

Ongoing



Komi håg vid montering av

LED-strålkastare

1. Installation och underhåll får endast utföras av behörig installatör.
2. Ljuskällan till denna armatur är inte utbyttbar, när den förbrukats ska hela armaturen bytas ut.
3. Notera att förändringar i kabelinstallation kan påverka IP-klassning.
4. Se till att fästskravar fixeras med fjäderbricka och dras åt ordentligt.
5. Jordledning måste vara väl ansluten.
6. Se till att strålkastaren är ansluten till korrekt ingångsspänning.
7. Använd inte kemikalier eller frätande rengöringsmedel för att rengöra armaturen.
8. Minsta avstånd från belysta objekt till armaturer ska vara minst 0,3 m.
9. Trasig lens måste bytas ut av certifierad tekniker.

Things to remember when installing LED Floodlights

1. Installation and maintenance must be performed by professionals only.
2. The light source of this luminaire is not replaceable; when the light source reaches its end of life the whole luminaire shall be replaced.
3. Note that changes in cable installation may affect IP rating.
4. Please make sure the hook was fixed with spring washer and tighten up.
5. Ground wire must be well connected.
6. Please make sure the lamp is working with correct input voltage.
7. Do not use chemicals or corrosive cleaner to clean the fixture.
8. The minimum distance from lighted objects to luminaires shall be kept at least 0.3m.
9. Broken Glass must be replaced by certified technician.

Mounting bracket

