

# S22 PROJEKTBELYSNING

S22-450, 500, 600, 900, 1000, 1250, 1350, 1500

T22-1500, 1800



POWER  
450  
WATT

POWER  
500  
WATT

POWER  
600  
WATT

POWER  
900  
WATT

POWER  
1000  
WATT

POWER  
1250  
WATT

POWER  
1350  
WATT

POWER  
1500  
WATT

POWER  
1800  
WATT

## INSTALLATION

### TILL ANVÄNDARE / FOR USERS

För att använda produkten på rätt sätt, var vänlig läs igenom manualen noggrant, före produkten tas i bruk.

To use the product correctly, please read the manual carefully before using the product.

### ALLMÄN PRODUKTBESKRIVNING / GENERAL PRODUCT DESCRIPTION

MODELL / MODEL	450	500	600	900	1000
MÄRKSPÄNNING / INPUT VOLTAGE	110-277VAC 50/60Hz				
LED EFFEKT (W) / LED POWER (W)	402-431	450-483	547-579	811-865	909-972
SYSTEMEFFEKT (W) / SYSTEM POWER (W)	428-459	479-512	569-605	858-920	963-1013
LUMEN (LM) / LUMINOUS FLUX (LM)	64,600-69,800	69,800-76,500	78,400-86,200	130,000-134,400	139,800-144,800
CCT (K)	4000 STANDARD (3000/5700)				
CRI	>70 STANDARD (>80)				
SPRIDNINGSVINKEL / BEAM ANGLE	12°/30°/60°/40°x15°/60°x15°/100°x17°/100°x60°/130°x25° (ALTERNATIVE LENSES FOR CUSTOMIZATION)				
ÖVERSPÄNNINGSSKYDD / SURGE PROTECTION	CM: 20KV, DM: 20KV				
OMGIVNINGSTEMPERATUR (°C) / WORKING TEMPERATURE (°C)	-20 - +40				

MODELL / MODEL	1250	1350	1500	1800
MÄRKSPÄNNING / INPUT VOLTAGE	110-277VAC 50/60Hz		110-277VAC (NFS: 200-480VAC) 50/60Hz	
LED EFFEKT (W) / LED POWER (W)	1136-1218	1221-1312	1351-1449	1642-1761
SYSTEMEFFEKT (W) / SYSTEM POWER (W)	1208-1256	1305-1357	1437-1536	1710-1834
LUMEN (LM) / LUMINOUS FLUX (LM)	165,800-172,100	198,000-209,000	212,200-231,000	245,800-263,900
CCT (K)	4000 STANDARD (3000/5700)			
CRI	>70 STANDARD (>80)			
SPRIDNINGSVINKEL / BEAM ANGLE	12°/30°/60°/40°x15°/60°x15°/100°x17°/100°x60°/130°x25° (ALTERNATIVE LENSES FOR CUSTOMIZATION)			
ÖVERSPÄNNINGSSKYDD / SURGE PROTECTION	CM: 20KV, DM: 20KV		CM: 20KV, DM: 20KV (NFS) CM: 10KV, DM: 10KV	
OMGIVNINGSTEMPERATUR (°C) / WORKING TEMPERATURE (°C)	-20 - +40			

### ANVÄNDNINGSMÅL / AREA OF USE

Belysning för stora ytor utomhus med högt satta krav på energieffektivitet, livslängd och flexibel installation.

Lighting for large areas outdoors with high demands on energy efficiency, lifetime and flexible installation.

### MÅTT (mm) / DIMENSIONS (mm)

S SERIES



450W, 500W, 600W

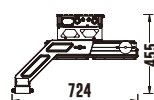

900W, 1000W, 1250W

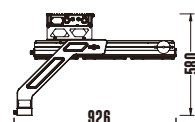

1350W, 1500W

T SERIES

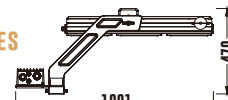

1500W, 1800W



**DESIGNLIGHT**

SCANDINAVIAN AB

URVAL AV MONTERINGSHÅL  
/ SELECTION OF MOUNTING HOLES

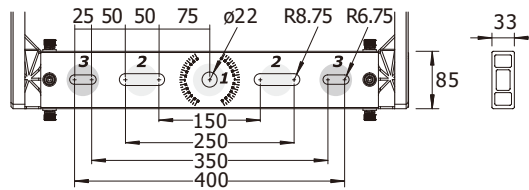

POS 1: 1x M20 (A2-70 ELLER STÖRRE)  
POS 2: 2x M16 (A2-70 ELLER STÖRRE)  
POS 3: 2x M12 (A2-70 ELLER STÖRRE)

POS 1: 1x M20 (A2-70 OR ABOVE)  
POS 2: 2x M16 (A2-70 OR ABOVE)  
POS 3: 2x M12 (A2-70 OR ABOVE)

MÅTT (mm) / DIMENSIONS (mm)

CONTROL GEAR (DRIVER BOX)

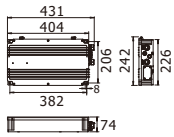

MATRIX: 450W-600W

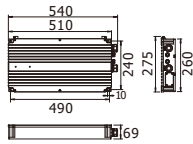

MATRIX: 900W-1500W

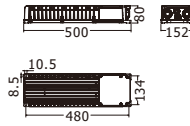

NFS: 1500W-1800W

VIKT (KG) / NET WEIGHT (KG)

POWER	LUMINAIRE	MATRIX (0/10V)	MATRIX (DALI-2)	NFS-1K8T210BC (DMX/DALI-2/D4)
450/500W	11.3	4.8	5.1	
600W	11.3	5.4	6.2	
900W	18.2	6.2	7.2	
1000W	18.2	6.2	7.2	
1250W	18.2	7.1	8.3	
1350W-1800W	25.6	7.9	9.3	
1500W/1800W	25.6			6.4

ANTAL ARMATURER PER SÄKRING / QTY OF PRODUCTS TO EACH CIRCUIT BREAKER

POWER	MATRIX (DALI-2)					
	B10	B16	C10	C16	D10	D16
450/500W (2x DRIVER)	0	1	1	2	2	4
600W (3x DRIVER)	0	0	0	1	1	3
900W (4x DRIVER)	2	4	2	4	2	4
1000W (4x DRIVER)	2	3	2	3	2	3
1250W (5x DRIVER)	1	2	1	2	1	2
1350/1500W (6x DRIVER)	1	2	1	2	1	2
1800W (7x DRIVER)	0	0	0	1	0	1

POWER	MATRIX (0/10V)					
	B10	B16	C10	C16	D10	D16
450/500W (2x DRIVER)	2	3	3	5	3	5
600W (3x DRIVER)	1	2	2	3	2	3
900W (4x DRIVER)	2	4	2	4	2	4
1000W (4x DRIVER)	2	3	2	3	2	3
1250W (5x DRIVER)	1	2	1	2	1	2
1350/1500W (6x DRIVER)	1	2	1	2	1	2
1800W (7x DRIVER)	0	0	0	1	0	1

POWER	NFS-1K8T210BC (DMX/DALI-2/D4)					
	B10	B16	C10	C16	D10	D16
1500/1800W (220VAC)	0	1	0	1	---	---
1500/1800W (400VAC)	0	1	1	1	---	---

EFFEKTIV PROJICERAD VINDYTA (EPA = SCX) / EFFECTIVE PROJECTED AREA (EPA = SCX)

ENHET/UNIT: M<sup>2</sup>



MODELL/ MODEL	LUTNINGSVINKEL/ TILT ANGLE	0°	10°	20°	30°	45°	60°
450W-600W		0.06	0.08	0.09	0.09	0.10	0.11
900W-1250W		0.08	0.09	0.10	0.13	0.15	0.18
1350W-1800W		0.08	0.09	0.11	0.14	0.17	0.19

MAXIMAL PROJICERAD YTA AV STRÅLKASTAREN /  
MAXIMUM PROJECTED AREA OF THE FLOODLIGHT:

	450W-600W	0.125
S SERIES	900W-1250W	0.260
	1350W-1500W	0.396
T SERIES	1500W-1800W	0.481

INSTALLATION / INSTALLATION STEPS

- Öppna lådan och kontrollera din produkt. Vid ev. skada, tag kontakt med ditt försäljningsställe.  
Open the box and check your product. In case of damage contact your merchandiser.
- Montera fästena på stolpen/väggen/ytan med rostfria skruvar.  
Fasten the brackets on the pole/ wall/ surface with stainless steel screws.
- Justera strålkastaren för att rikta ljuset i önskad riktning innan du drar åt skruvarna.  
Adjust the floodlight to direct the light in desired direction before tightening the screws.
- Se till att anslutningskabeln är rätt ansluten. Brun – Fas, Blå – Noll, Gul/Grön – Jord.  
Försäkra dig om att strömkabeln är dragavlastad och att anslutningen är vattentät.  
Be sure to connect the wires correctly. Brown- Live, Blue- Null, Yellow/Green- grounding.  
Make sure power cord was fixed for anti-pull purpose, and the connection is waterproof in outdoor application.
- Slå på strömmen och kontrollera att armaturen fungerar som den ska.  
Switch the voltage on and check to see that the floodlight works properly.

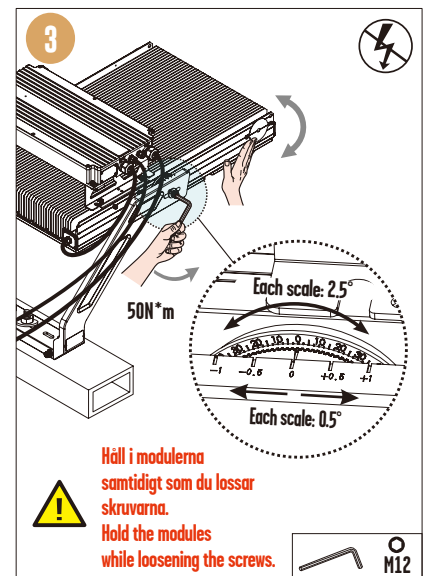
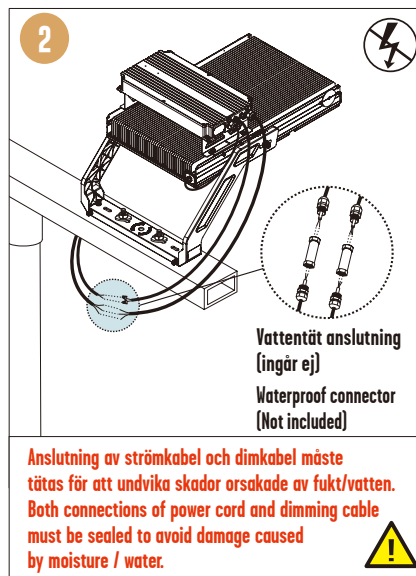
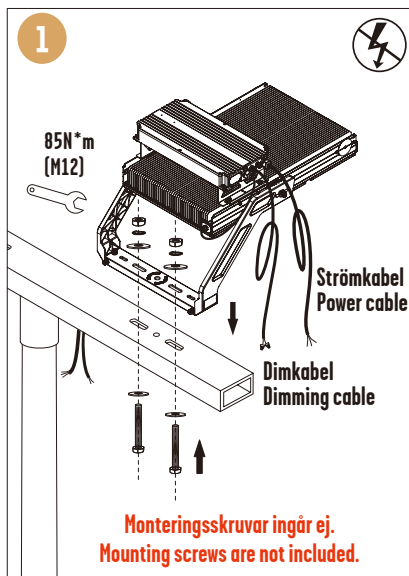

## PLACERING / PLACEMENT

### Godkänd placering ✓

Denna strålkastare kan installeras på stolpe, vägg, tak eller på en horisontell yta.

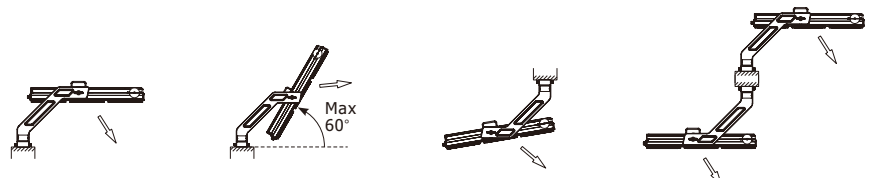

### Position allowed ✓

This Modular floodlight can be installed on pole, wall, ceiling or on a horizontal surface.

### Placering inte godkänd ✗

OBS: Med tanke på värme, fuktavledning, vindfång och andra faktorer är vissa typer av montage inte tillåtna.

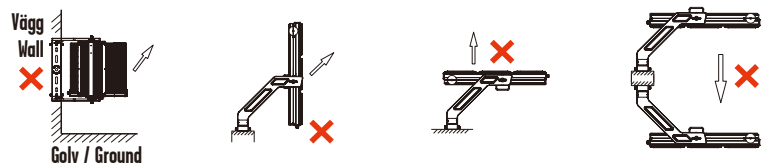

### Position not allowed ✗

Due to environmental factors and lifetime calculations, certain types of assembly are not permitted.

## KABELDRAGNING AV SEPARAT CONTROL GEAR / WIRING OF SEPARATED CONTROL GEAR SOLUTION

### MATRIX



BARA EN 3-LEDARKABEL / ONLY ONE 3-CORE CABLE

### 1 ANSLUTNING AV ARMATUR / CONNECTION OF LUMINAIRE

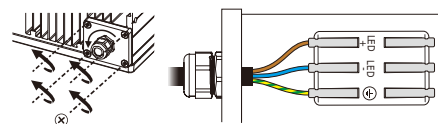

### 2 KABELGENOMFÖRING TILL CONTROL GEAR / CABLE GLAND OF CONTROL GEAR

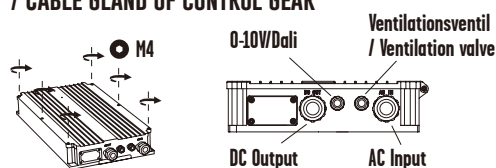

ANSLUTNING CONNECTION	KABELGENOMFÖRING CABLE GLAND	TORQUE (N*m)	KABELDIAMETER (MM) CABLE DIAMETER (MM)	KABELAREA (MM²) CABLE SECTION (MM²)
AC INPUT	M20	5,5	10-12	1,5 (2,5)
DC OUTPUT	M20	5,5	10-12	1,5 (2,5)
DIMMABLE	M16	2,5	7-10	1,0-1,5

### 3 CONTROL GEAR (0-10V/DALI)

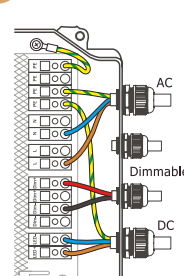

**OBS:** Enligt de faktiska behoven kan antalet anslutningar öka eller minska.  
Olika dimningsfunktioner kan inte användas samtidigt.  
**NOTE:** According to the actual needs, the number of connectors will increase or decrease.  
Different dimming function cannot be used at the same time.



**1 ANSLUTNING AV ARMATUR / CONNECTION OF LUMINAIRE**

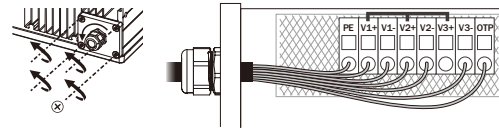

**2 KABELGENOMFÖRING TILL CONTROL GEAR / CABLE GLAND OF CONTROL GEAR**

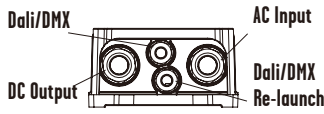
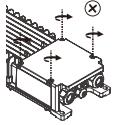

ANSLUTNING CONNECTION	KABELGENOMFÖRING CABLE GLAND	TORQUE (N * M)	KABELDIAMETER (MM) CABLE DIAMETER (MM)	KABELAREA (MM²) CABLE SECTION (MM²)
AC INPUT	M25	5,5	9-13	1,5 (2,5)
DC OUTPUT	M25	5,5	12-17	1,5
DIMMABLE	M16	2,5	6,5-10	0,75-1,5



Caution: Non-isolated driver, wrong connection could damage the driver or luminaire.

**3 CONTROL GEAR (DALI / DMX)**

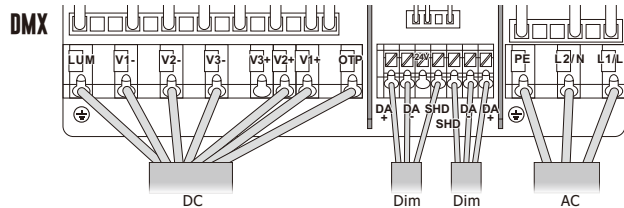
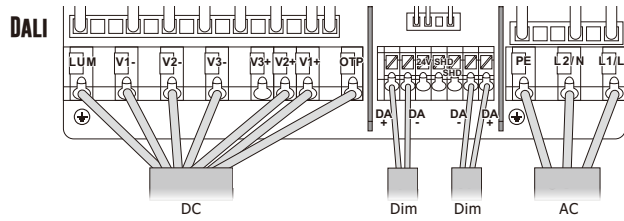

POWER	CROSS-SECTIONAL AREA	MAX CABLE LENGTH
450W	3x 1,5 MM²	300M
	3x 2,5 MM²	450M
500W	3x 1,5 MM²	250M
	3x 2,5 MM²	400M
600W	3x 1,5 MM²	200M
	3x 2,5 MM²	350M
900W	3x 1,5 MM²	150M
	3x 2,5 MM²	250M
	3x 4,0 MM²	400M
1000W	3x 1,5 MM²	100M
	3x 2,5 MM²	200M
	3x 4,0 MM²	350M
1250W	3x 1,5 MM²	100M
	3x 2,5 MM²	150M
	3x 4,0 MM²	250M
1350W	3x 1,5 MM²	100M
	3x 2,5 MM²	150M
	3x 4,0 MM²	250M
1500W	3x 1,5 MM²	50M
	3x 2,5 MM²	150M
	3x 4,0 MM²	200M
1500W(NFS)	3x 1,5 MM²	250M
1800W(NFS)	3x 1,5 MM²	200M

**INSTALLATION AV CONTROL GEAR (DRIVER BOX) / INSTALLATION OF CONTROL GEAR (DRIVER BOX)**

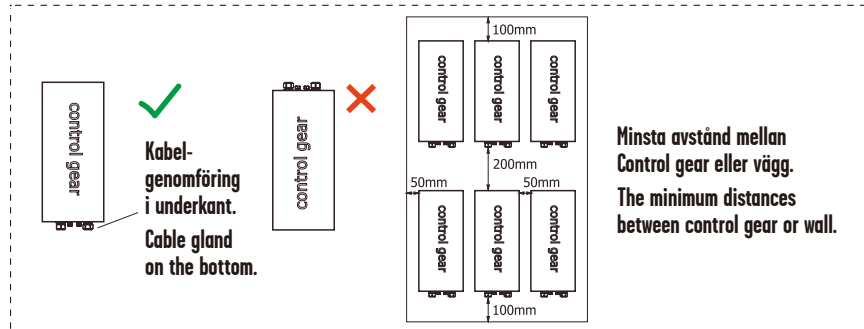

**SÄKERHET / SAFETY**

- Läs igenom hela manualen noggrant före installation.
  - Försäkra dig om att spänningen är frånslagen före installation eller underhåll.
  - Installation ska utföras av behörig elektriker.
- Read the entire manual carefully before installation.
  - Make sure that the voltage is switched off before installation or maintenance.
  - Installation must be performed by a qualified electrician.

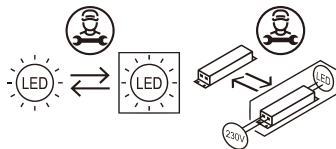

**FÖRBRUKADE ARMATURER / WASTE OF ELECTRICAL AND ELECTRONIC EQUIPMENT**

LED-lampor måste kasseras i enlighet med gällande regler för miljöskydd. Förbrukade armaturer ska lämnas som elektronikskrot till miljö/återvinningscentral där de tas emot utan kostnad. Korrekt retur av uttjänt elektronikutrustning gör det möjligt att bevara värdefulla miljöresurser och undvika negativa effekter på hälsa och miljö, vilket kan hotas av olämplig avfallshantering.

LED lamps must be disposed in accordance with current regulations for environmental protection. Used luminaires must be handed over as electronic waste to an environmental/recycling center where they will be accepted free of charge. Correct return of end-of-life electronic equipment makes it possible to preserve valuable environmental resources and avoid negative effects on health and the environment, which can be threatened by inappropriate waste management.



**DESIGNLIGHT**  
SCANDINAVIAN AB