



DESIGNLIGHT

SCANDINAVIAN AB

TRACKY TRACKLIGHT, DALI

E-NR: 74 753 51

ART NR: P-820MW DALI

EFFEKT POWER	MATERIAL	KELVIN	ARMATURFÄRG ARMATURE COLOR	ANSLUTNING CONNECTION	TOTAL LUMEN	USEFUL LUMEN
20W WITH DRIVER	ALUMINIUM	3000K	MATT WHITE	230V	1887LM	1856LM

CE, ROHS  

500MA
LED 1x18,2W
LIGHT SOURCE WATT

  **6316**
CD   **CRI: >80**  **24/36°**

 **LIFETIME**
L70B50: 50.000H     **IP20**  **H 185**
MM  **65MM**

- SPOTLIGHT FÖR 3-FASSYSTEM
- INBYGGT DRIVDON FÖR KOMPAKT OCH DISKRET LJUSSÄTTNING

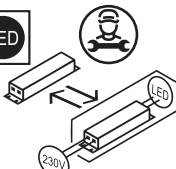

- MEDFÖLJANDE REFLEKTORER FÖR ANPASSNING TILL MILJÖ OCH OBJEKT
- STÄLLBART ARMATURHUS

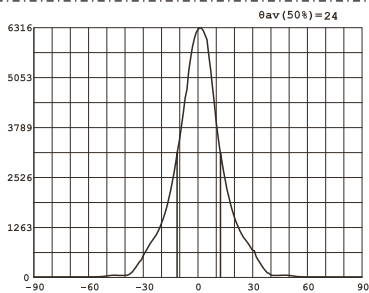
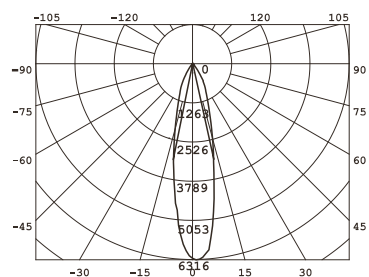

Avstånd	Belysningsstyrka	Spridnings vinkel 24°	Diam.
0.5m	12466.74lx	25151.15lx	20.83cm
1.0m	4362.19lx	6297.79lx	41.66cm
1.5m	1938.75lx	2789.02lx	62.49cm
2.0m	1090.55lx	1574.45lx	83.32cm
3.0m	484.69lx	699.75lx	124.98cm

1. Stäng av strömmen/Turn off the power

2. Make sure the metal contacts conceal inside the adaptor, before insert into track.

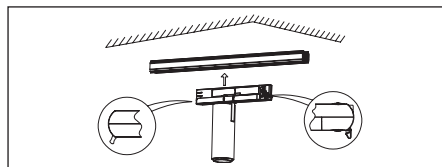

3. Lock the adaptor into track by switching the A&B handles clockwise.

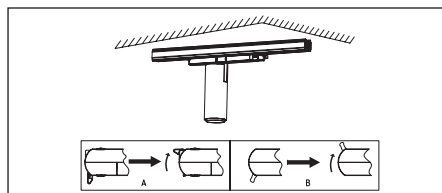

4. Turn the switch to select the correct circuit.

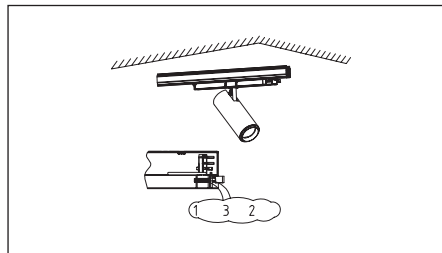

Mått/Dimension

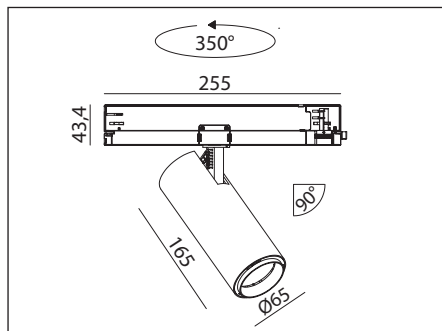

**PRODUKTEN INNEHÅLLER
LJUSKÄLLA MED
ENERGIMÄRKNING
KLASS E.**

⚠ SÄKERHET:

- 1 Läs igenom hela manualen noggrant före installation.
- 2 Försäkra dig om att spänningen är frånslagen före installation eller underhåll.
- 3 Installation ska utföras av behörig elektriker.
- 4 Ljuskällan är ej utbyttbar. Hela armaturen måste bytas när ljuskällan är förbrukad.

⚠ SAFETY:

- 1 Read the entire manual carefully before installation.
- 2 Make sure that the power is switched off before installation or maintenance.
- 3 Installation must be performed by a qualified electrician.
- 4 The light source of this luminaire is not replaceable; when the light source reaches its end of life the whole luminaire shall be replaced.

1.900K	2.700-3.000K	4.000-4.500K	4.800K	5.000-5.000K	7.000-7.500K	10.000K
STEARINLJUS CANDLE	VARMVIT WARM WHITE	NATURLIG VIT NATURAL WHITE	SOLLJUS DIRECT SUN	VITT DAGSLJUS DAY WHITE	KALLVIT COOL WHITE	BLÅ HIMMEL BLUE SKY

DESIGNLIGHT
SCANDINAVIAN AB

DESIGNLIGHT SCANDINAVIAN AB · TOFFELVÄGEN 1 · 342 60 MOHEDA
KUNDCENTER: TELEFON 0472-716 10 · FAX 0472-716 09 · INFO@DESIGNLIGHT.NU · WWW.DESIGNLIGHT.NU