



DESIGNLIGHT

SCANDINAVIAN AB

DOWNLIGHT

E-NR: 74 744 73

ART NR: Q-25MW

EFFEKT POWER	MATERIAL	KELVIN	ARMATURFÄRG	ANSLUTNING CONNECTION	LUMEN LUMEN
1,2W	ALUMINIUM	2700K	WHITE	350MA	59LM

CE, ROHS, IP CERTIFIED BY SGS  

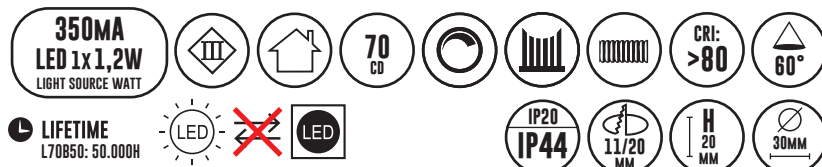

- ANPASSAD FÖR MONTAGE I 16 MM FLEXRÖR
- KONCENTRERAD LJUSBILD
- PERFECT FÖR FÖNSTERMYGAR, BADRUM MM
- SKAPAR EFFEKTFULL BELYSNING

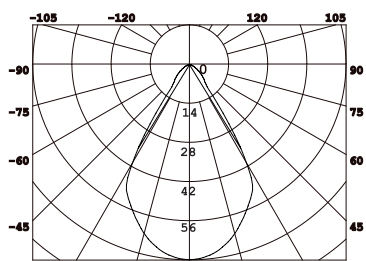

θ_{50%} (50%) = 60°

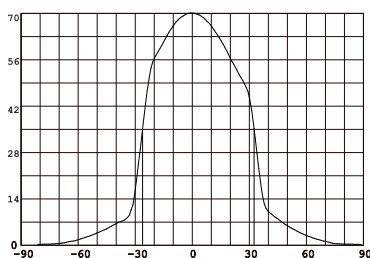

Avstånd	Belysningsstyrka	Spridnings vinkel 60°	Diam.
0.50m	163.1lx 264.1lx		59.47cm
1.00m	40.78lx 66.02lx		118.94cm
1.50m	18.12lx 29.34lx		178.40cm
2.00m	10.20lx 16.50lx		237.87cm
3.00m	4.53lx 7.35lx		356.81cm

1. Stäng av strömmen/Turn off the power

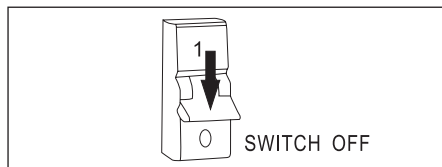

2. Borra hål i taket/Drill hole in ceiling

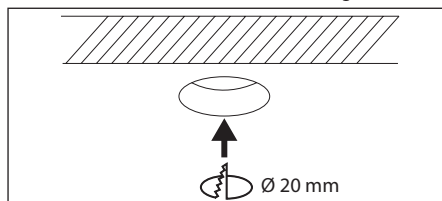

3. Anslut till LED-drivern/Connect to LED driver

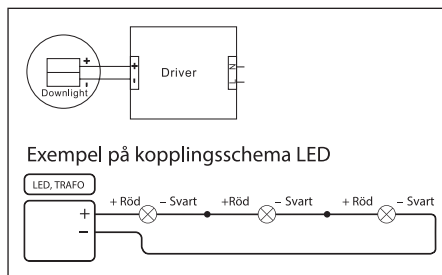

Mått/Dimension

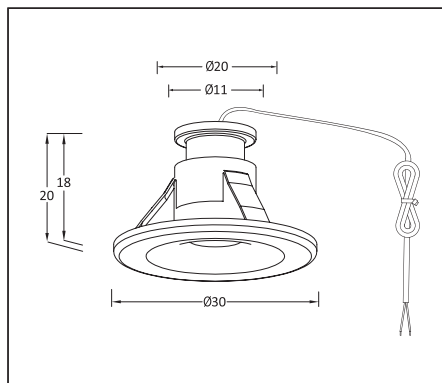

! SÄKERHET:

- 1 Läs igenom hela manualen noggrant före installation.
- 2 Kontrollmät ALLTID diametern före håltagning i tak.
- 3 Kontrollera att drivdonet är anpassat för det antal lampor som ska installeras.
- 4 Försäkra dig om att spänningen är fränslagen före installation eller underhåll.
- 5 Installation ska utföras av behörig elektriker.
- 6 Ljuskällan är ej utbyttbar. Hela armaturen måste bytas när ljuskällan är förbrukad.

! SAFETY:

- 1 Read the entire manual carefully before installation.
- 2 ALWAYS check the diameter before drilling holes in the ceiling.
- 3 Check that the driver is adapted to the number of lamps to be installed.
- 4 Make sure that the power is switched off before installation or maintenance.
- 5 Installation must be performed by a qualified electrician.
- 6 The light source of this luminaire is not replaceable, when the light source reaches its end of life the whole luminaire shall be replaced.

1.900K	2.700-3.000K	4.000-4.500K	4.800K	5.000-5.000K	7.000-7.500K	10.000K
STEARINLJUS CANDLE	VARMVIT WARM WHITE	NATURLIG VIT NATURAL WHITE	SOLLJUS DIRECT SUN	VITT DAGSLJUS DAY WHITE	KALLVIT COOL WHITE	BLÅ HIMMEL BLUE SKY

DESIGNLIGHT
SCANDINAVIAN AB

DESIGNLIGHT SCANDINAVIAN AB · TOFFELVÄGEN 1 · 342 60 MOHEDA
KUNDCENTER: TELEFON 0472-716 10 · FAX 0472-716 09 · INFO@DESIGNLIGHT.NU · WWW.DESIGNLIGHT.NU