



DESIGNLIGHT

SCANDINAVIAN AB

Art nr: P-G6276

E-nr: 74 746 50

Effekt Power	Material Material	Färgtemperatur Color temperature	Armaturfärg Fixture color	Anslutning Connection	Ljusflöde Luminous flux
6x7W	Aluminium	2700K	Matt White	230V	6x550lm

CE, ROHS, IP CERTIFIED BY SGS



- Dimbar med 350 mA driver
- 78 lm/w med lens, driver
- 92 lm/w utan lens, driver
- CRI Värde > 90
- Dimmable with 350 mA driver
- 78 lm/W with lens, driver
- 92 lm/W without lens, driver
- CRI value > 90

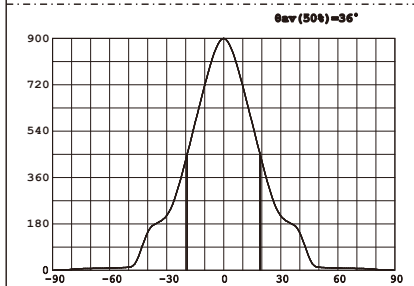
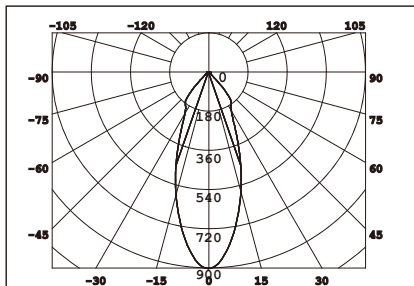
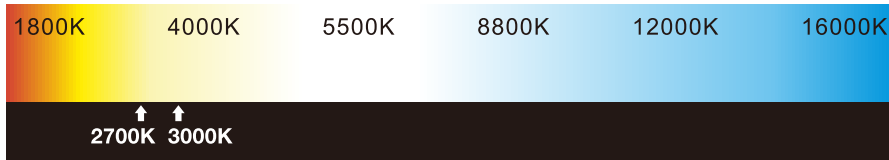

Avstånd	Belysningsstyrka	Spridnings vinkel 36°	Diam.
0.50m	2243lx 3441lx		34.32cm
1.00m	560.6lx 860.2lx		68.64cm
1.50m	249.2lx 382.3lx		102.97cm
2.00m	140.2lx 215.3lx		137.29cm
3.00m	62.29lx 95.58lx		205.93cm

1. Stäng av strömmen/Turn off the power

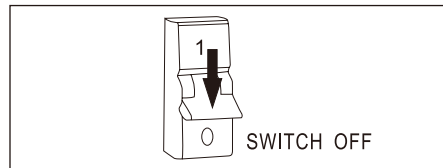

2. Borra hål i taket/Drill hole in ceiling

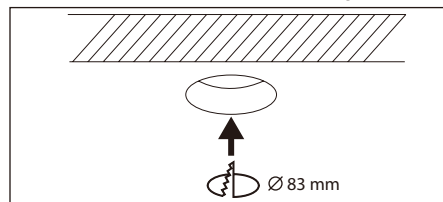

3. Anslut till LED-drivern/Connect to LED driver

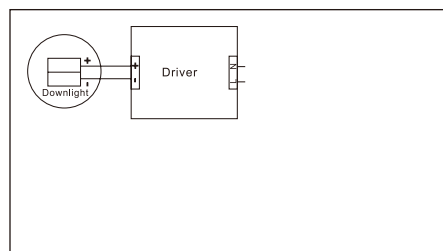

Mått/Dimension

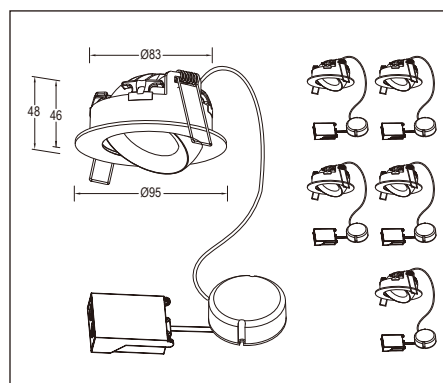

This luminaire contains built-in LED lamps.

A++
A+
A
B
C
D
E

LED

The lamps cannot be changed in the luminaire.

874/2012

Komihåg vid montering av downlight LED

Kontrollmät **ALLTID** diametern före håltagning i tak. Antal watt per lampa x antalet lampor ger storleken på transformator. Vid installation av LED följ **ALLTID** kopplingschema.

- OBS! Det är olika transformatorer på LED och halogen.
- 1-2W/kvm vid mjukare belysning normal takhöjd.
- 3-4W/kvm vid allmän belysning normal takhöjd.

LED är:

- Miljövänlig och energisnål.
- Lång livslängd, 20.000-50.000 timmar.
- Låg värmeutveckling, stötsäker.

Trivs bäst i kyla, ju lägre temperatur och god luftarea desto bättre ljuseffekt. För ökad livslängd på LED-lampor bör armaturer med kylfläns användas.

Tänk på att **ALDRIG** montera downlight direkt mot lättantändligt material. Desto mer luftarea runt den monterade downlighten, desto säkrare blir installationen. Ökad luftarea ger längre livslängd på ljuskälla och armatur.

Things to remember when installing LED downlights

ALWAYS measure the diameter prior to perforation in ceiling. The amount of Watt per light times the number of lights equal the size of transformer. During installation of LED, **ALWAYS** adhere to the circuit diagram.

N.B. Transformers differ for LED and halogen.

- 1-2W/square meter for softer lighting and standard ceiling height.
- 3-4W/square meter for ambient lighting and standard ceiling height.

LED is:

- Environmentally friendly and energy efficient.
- Long life expectancy, 20 000-50 000 hours.
- Low heat generation, shock resistant.

LED lights perform at best in cold, the lower the temperature and the more air volume, the better the light output. For increased longevity on LED lights, fixtures with heat sinks should be used.

Remember to **NEVER** install a downlight directly adjacent flammable materials. Sufficient air volume surrounding the installed fixture provides a safer installation. Increased air volume increases life expectancy for both light source and fixture.



DESIGNLIGHT

SCANDINAVIAN AB

Designlight Scandinavian AB | Toffelvägen 1 | SE-342 60 Moheda

Kundcenter: Telefon 0472-716 10 | Fax 0472-716 09 | info@designlight.nu | www.designlight.nu

www.designlight.nu