



DESIGNLIGHT

SCANDINAVIAN AB

TRACKY TRACKLIGHT

E-NR: 74 746 44

ART NR: P-813B

EFFEKT POWER	MATERIAL MATERIAL	KELVIN KELVIN	ARMATURFÄRG ARMATURE COLOR	ANSLUTNING CONNECTION	TOTAL LUMEN	USEFUL LUMEN
13W WITH DRIVER	ALUMINIUM	3000K	MATT BLACK	230V	1200LM	1111LM

CE, RoHS, IP CERTIFIED BY SGS



- SPOTLIGHT FÖR 3-FASSYSTEM
- INBYGGT DRIVDON FÖR KOMPAKT OCH DISKRET LJUSSÄTTNING

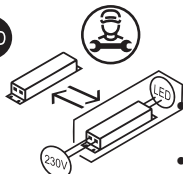

- MEDFÖLJANDE REFLEKTORER FÖR ANPASSNING TILL MILJÖ OCH OBJEKT
- STÄLLBART ARMATURHUS

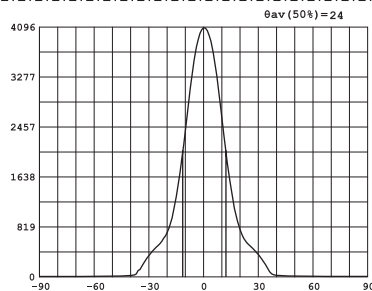
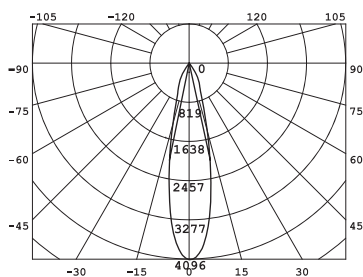

Avstånd	Belysningsstyrka	Spridnings vinkel 24°	Diam.
0.5m	11610.55lx 16444.13lx		20.90cm
1.0m	2902.64lx 4111.03lx		41.61cm
1.5m	1290.06lx 1827.13lx		62.41cm
2.0m	725.66lx 1027.76lx		83.21cm
3.0m	322.52lx 456.78lx		124.82cm

1. Stäng av strömmen/Turn off the power
2. Turn the switch to unlock position to conceal the metal contacts on adaptor, before install the spot light into track.

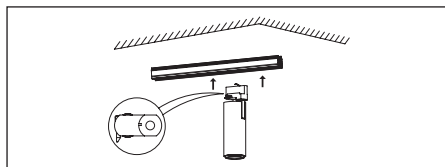

3. Turn the switch clockwise to lock the adaptor, after inserting the spot light into track.

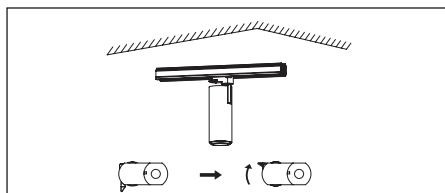

4. Turn the phase selector to the correct phase number. Sequence is 1->0->3->0->2; 0 for void.

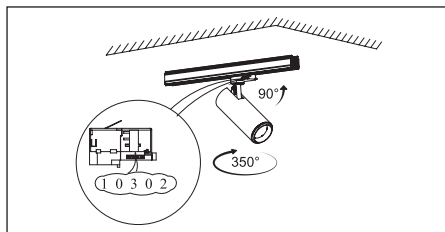

Mått/Dimension

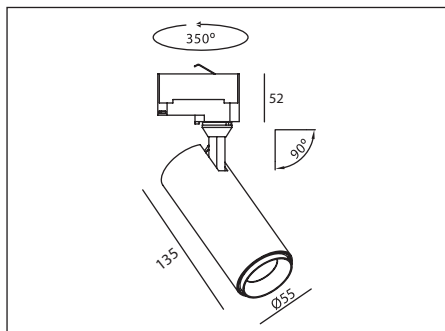

PRODUKTEN INNEHÅLLER LJUSKÄLLA MED ENERGIMÄRKNING KLASS F.

⚠ SÄKERHET:

1. Läs igenom hela manualen noggrant före installation.
2. Kontrollmät ALLTID diametern före håltagning i tak.
3. Försäkra dig om att spänningen är fränslagen före installation eller underhåll.
4. Installation ska utföras av behörig elektriker.
5. Ljuskällan är ej utbyttbar. Hela armaturen måste bytas när ljuskällan är förbrukad.

⚠ SAFETY:

1. Read the entire manual carefully before installation.
2. ALWAYS check the diameter before drilling holes in the ceiling.
3. Make sure that the voltage is switched off before installation or maintenance.
4. Installation must be performed by a qualified electrician.
5. The light source of this luminaire is not replaceable, when the light source reaches its end of life the whole luminaire shall be replaced.

1.900K	2.700-3.000K	4.000-4.500K	4.800K	5.000-5.000K	7.000-7.500K	10.000K
STEARINLJUS CANDLE	VARMVIT WARM WHITE	NATURLIG VIT NATURAL WHITE	SOLLJUS DIRECT SUN	VITT DAGSLJUS DAY WHITE	KALLVIT COOL WHITE	BLÅ HIMMEL BLUE SKY

DESIGNLIGHT
SCANDINAVIAN AB

DESIGNLIGHT SCANDINAVIAN AB · TOFFELVÄGEN 1 · 342 60 MOHEDA
KUNDCENTER: TELEFON 0472-716 10 · FAX 0472-716 09 · INFO@DESIGNLIGHT.NU · WWW.DESIGNLIGHT.NU