



# DESIGNLIGHT

SCANDINAVIAN AB

## DOWNLIGHT, FAST

### E-NR: 74 676 00

### ART NR: P-752 DALI

EFFEKT POWER	MATERIAL MATERIAL	KELVIN KELVIN	ARMATURFÄRG ARMATURE COLOR	ANSLUTNING CONNECTION	TOTAL LUMEN	USEFUL LUMEN
18W WITH DRIVER	ALUMINIUM	3000K	WHITE	230V	1727LM	1690LM

CE, ROHS, IP CERTIFIED BY SGS

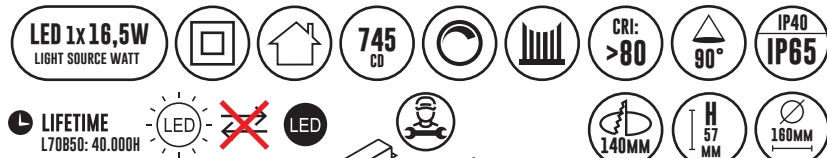

LIFETIME L70B50: 40.000H

- DALI
- STILREN ARMATUR FÖR OFFENTLIG MILJÖ

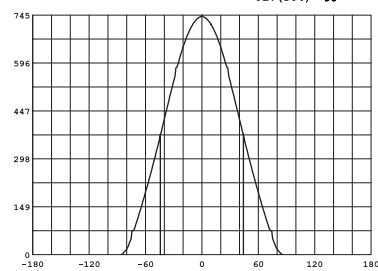
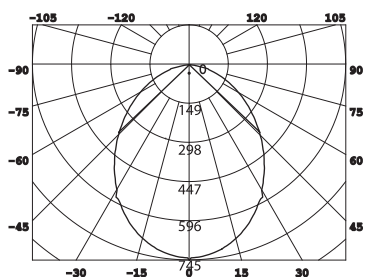

Avstånd	Belysningsstyrka	Spridnings vinkel 90°	Diam.
0.50	1227.03lx	2980.90lx	104.72cm
1.00	306.76lx	745.22lx	209.44cm
1.50	136.34lx	331.21lx	314.17cm
2.00	76.69lx	186.31lx	418.89cm
3.00	34.08lx	82.80lx	628.33cm

1. Stäng av strömmen/Turn off the power

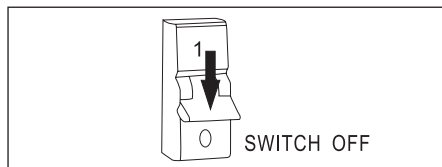

2. Borra hål i taket/Drill hole in ceiling

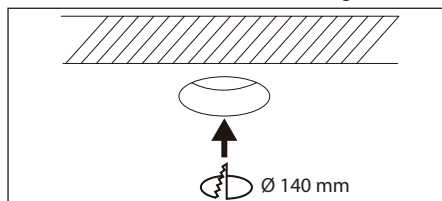

3. Anslut till LED-drivern/Connect to LED driver

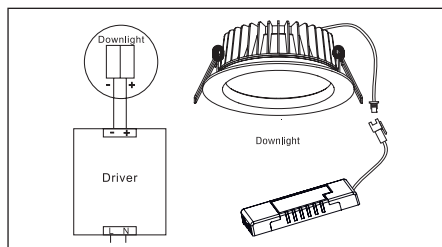

Mått/Dimension

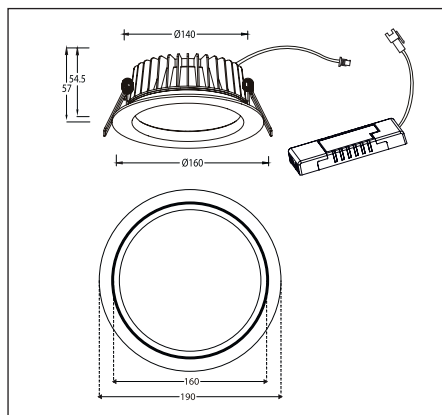

### PRODUKTEN INNEHÅLLER LJUSKÄLLA MED ENERGIMÄRKNING KLASS E.

#### ⚠ SÄKERHET:

- 1 Läs igenom hela manualen noggrant före installation.
- 2 Kontrollmät ALLTID diametern före håtagning i tak.
- 3 Försäkra dig om att spänningen är fränslagen före installation eller underhåll.
- 4 Installation ska utföras av behörig elektriker.
- 5 Ljuskällan är ej utbyttbar. Hela armaturen måste bytas när ljuskällan är förbrukad.

#### ⚠ SAFETY:

- 1 Read the entire manual carefully before installation.
- 2 ALWAYS check the diameter before drilling holes in the ceiling.
- 3 Make sure that the voltage is switched off before installation or maintenance.
- 4 Installation must be performed by a qualified electrician.
- 5 The light source of this luminaire is not replaceable, when the light source reaches its end of life the whole luminaire shall be replaced.

1.900K	2.700-3.000K	4.000-4.500K	4.800K	5.000-5.000K	7.000-7.500K	10.000K
STEARINLJUS CANDLE	VARMVIT WARM WHITE	NATURLIG VIT NATURAL WHITE	SOLLJUS DIRECT SUN	VITT DAGSLJUS DAY WHITE	KALLVIT COOL WHITE	BLÅ HIMMEL BLUE SKY

**DESIGNLIGHT**  
SCANDINAVIAN AB

DESIGNLIGHT SCANDINAVIAN AB · TOFFELVÄGEN 1 · 342 60 MOHEDA  
KUNDCENTER: TELEFON 0472-716 10 · FAX 0472-716 09 · INFO@DESIGNLIGHT.NU · WWW.DESIGNLIGHT.NU